

TYPICAL REPAIR METHOD FOR A CUT 2x4 TOP CHORD AND A NOTCHED WEB

SITUATION BEFORE REPAIR

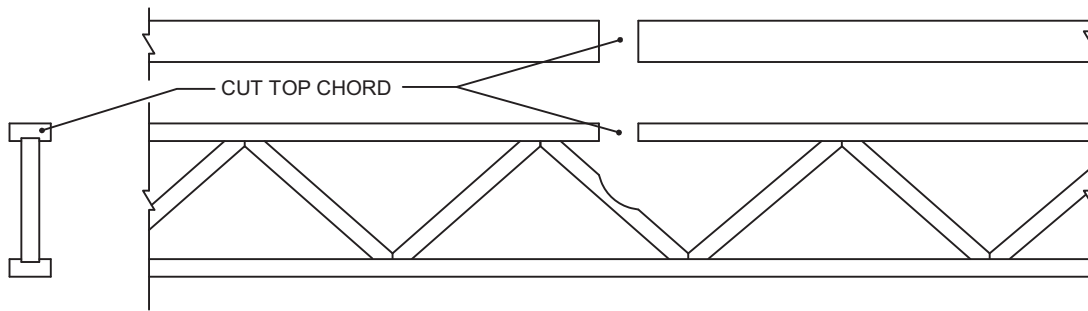

SITUATION AFTER REPAIR

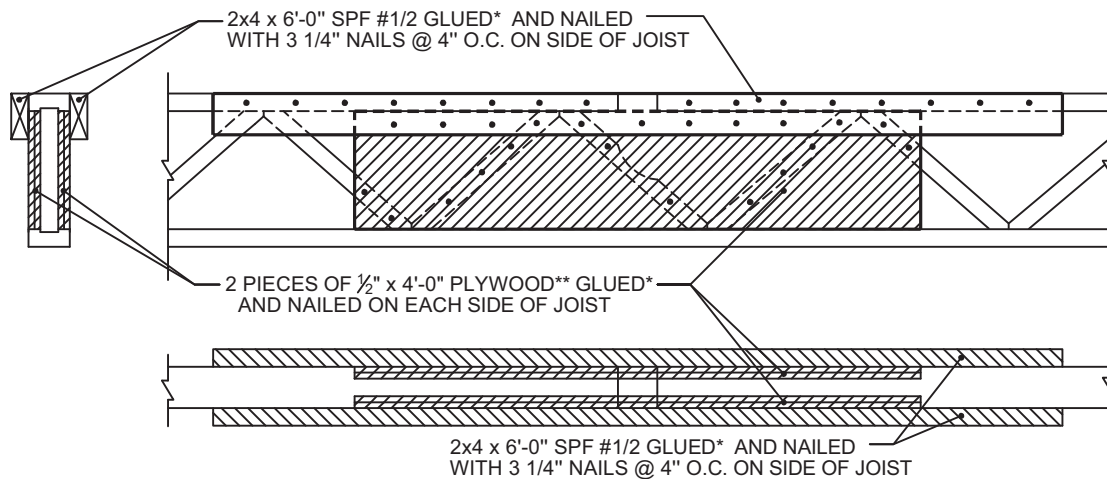

*PL PREMIUM GLUE
** Plywood - at least 1/2" 4 ply (15/32") or better

RTF-011-18

IMPORTANT NOTICES

This detail drawing is valid for uniform residential loads.
For other types of loads, contact the manufacturer.
Check out the www.openjoisttriforce.com website for the latest updates.

